



CURRENEX
GLOBAL FINANCIAL EXCHANGE

Treasury Workstation Integration: Comparison of Twist to current FpML-fx

Bill Specht, Financial Software Architect

October 22, 2001

Currenex Proprietary & Confidential

FpML Element

Twist

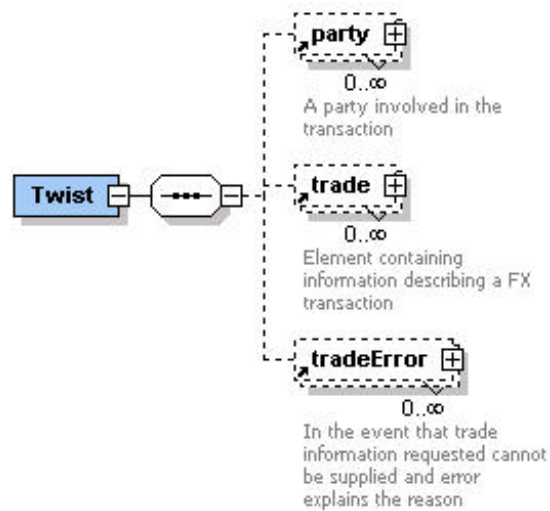

Twist supports multiple trades
Party outside of trade supports multiple trades referencing same party
Errors are reported when downloading if something is wrong with a trade

FpML-fx

Moving party outside of trade is being presented to the FpML board



Trade Element

Twist

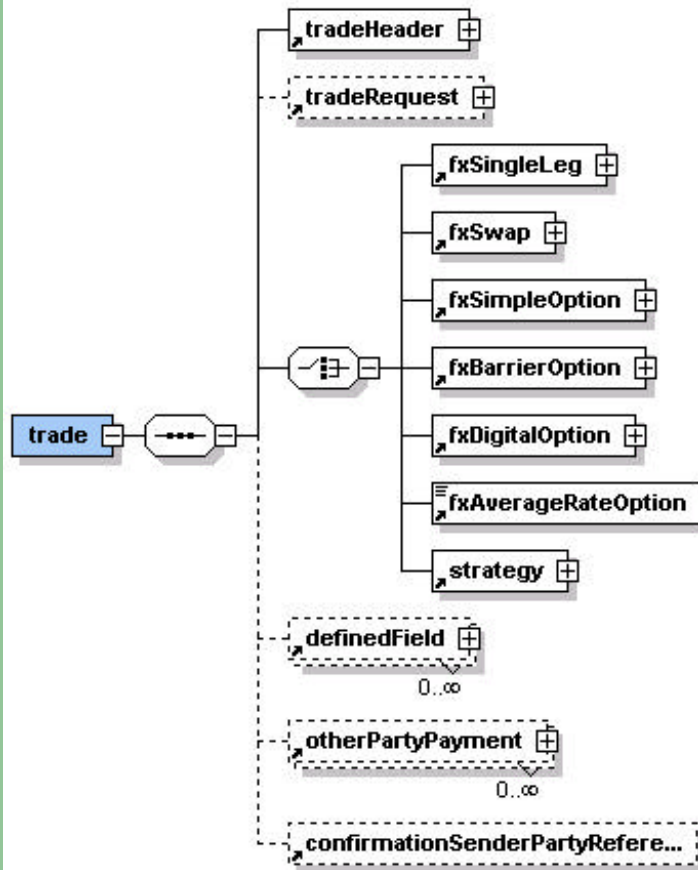

FpML-fx

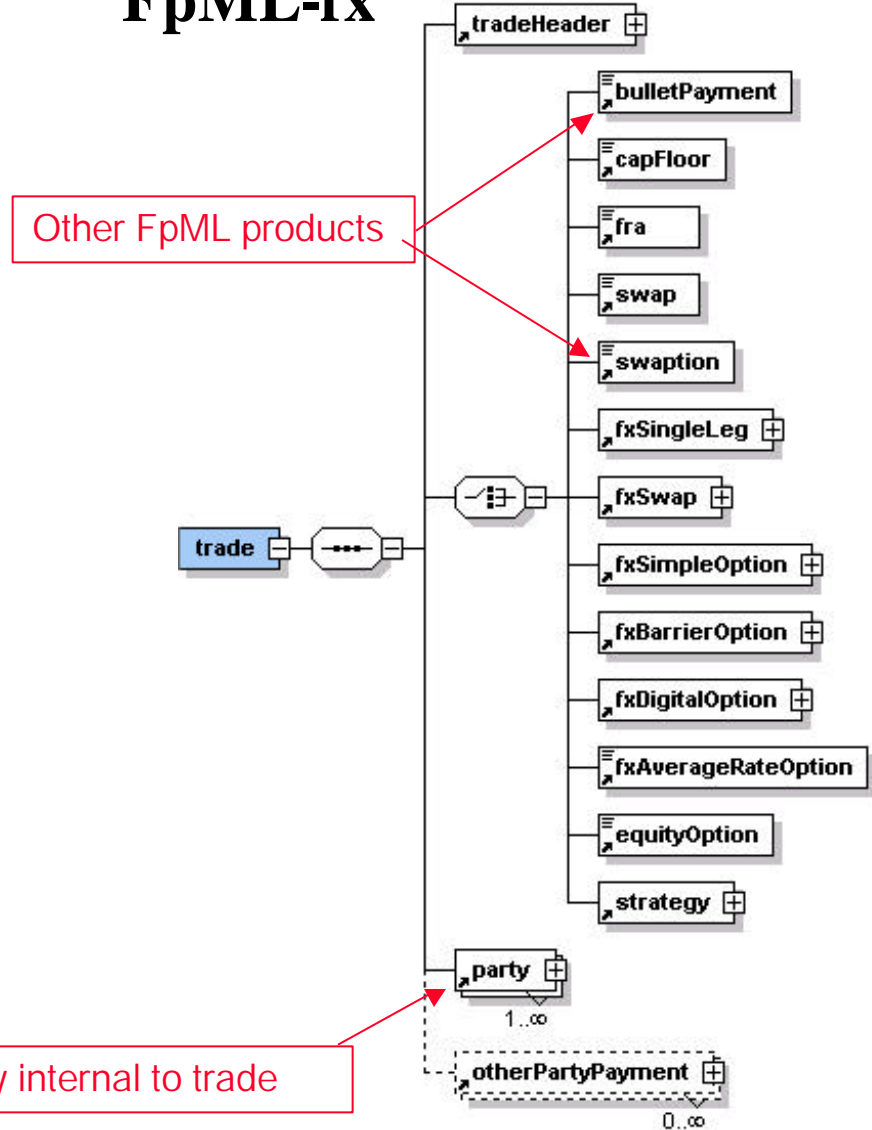

Trade Request Element

Twist

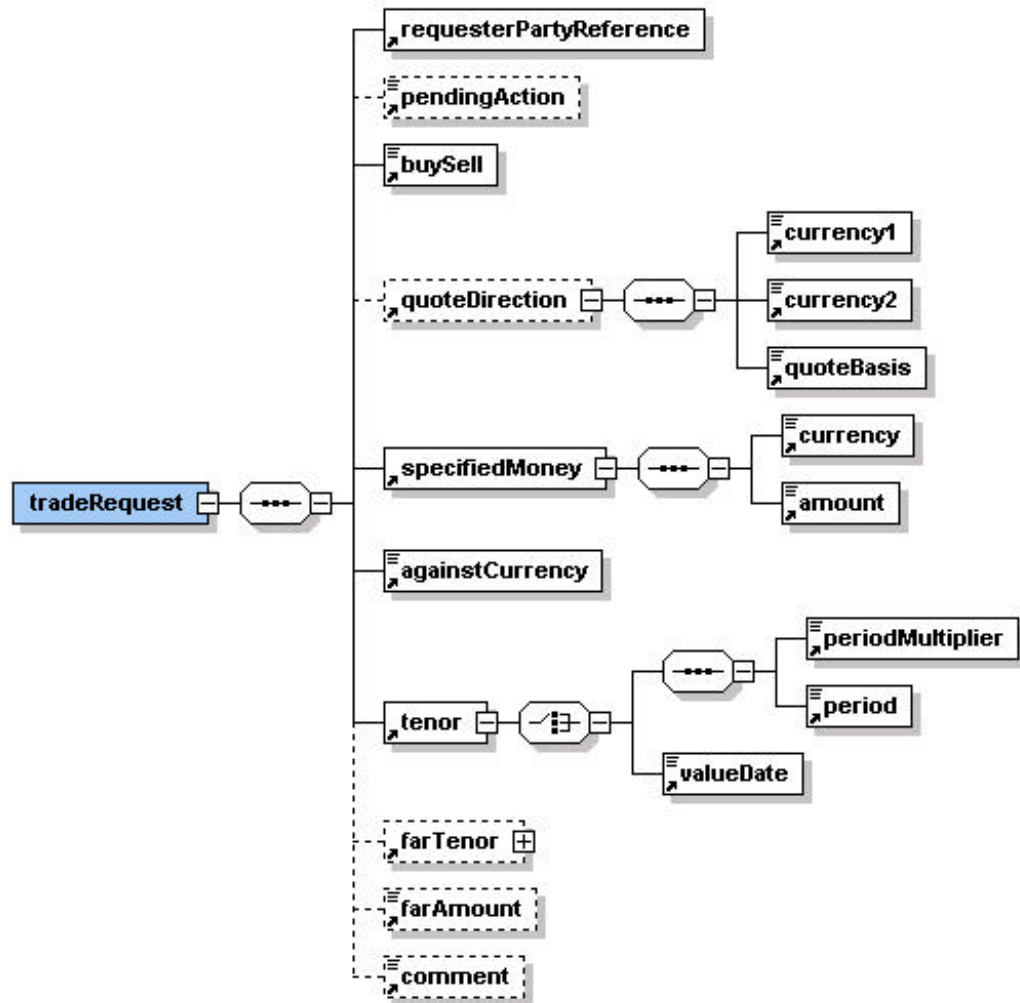

The Trade Request Element records how the trade was originally requested and which counterparty made the request.

Defined Field Elements

Twist

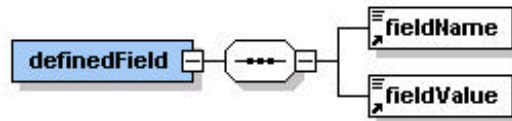

Defined fields are extensions to standard fields included in the specification. These name/value pairs can be added by a user to extend the specification using an agreed syntax

TradeHeader Element

Twist

FpML-fx

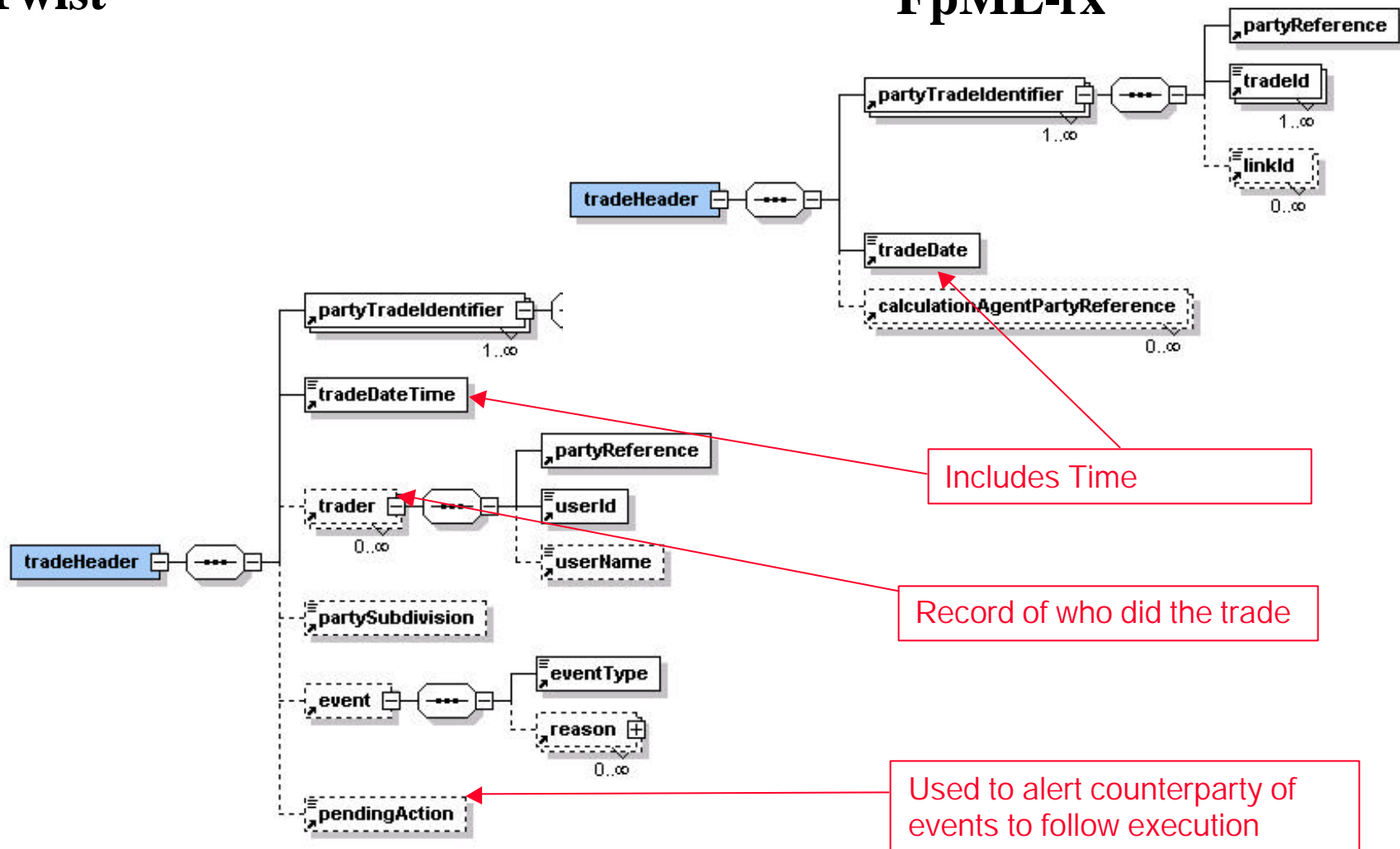

PartyTradeIdentifier Element

Twist

FpML-fx

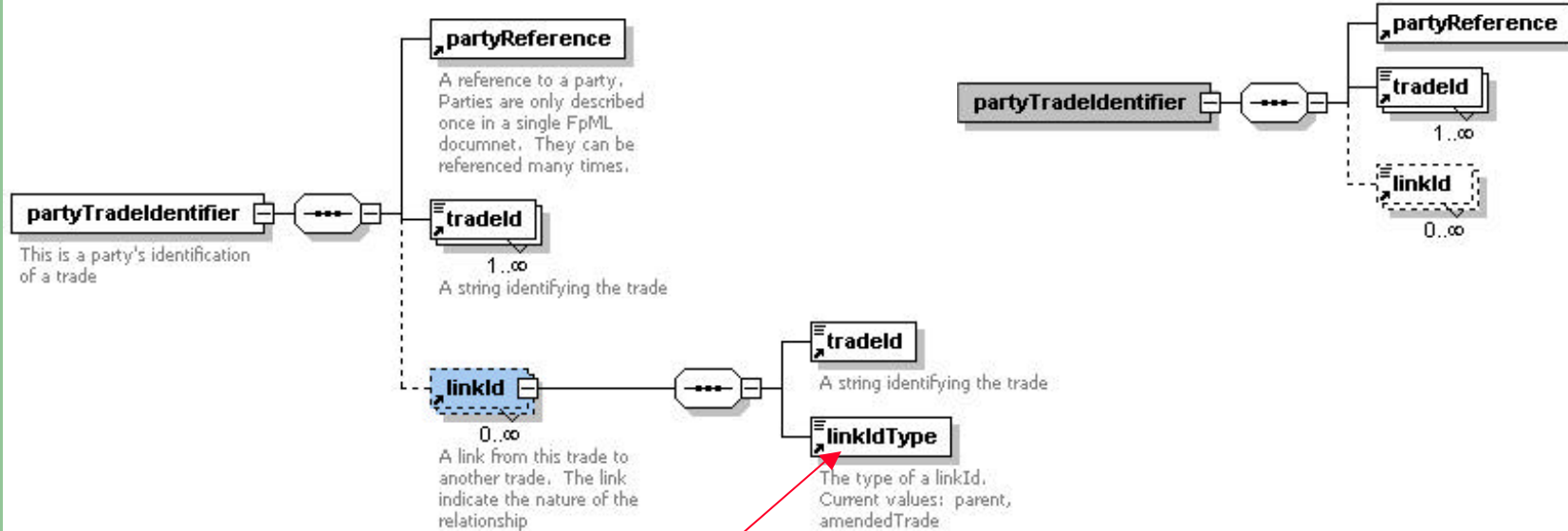

Purpose of link supported

Event Element

Twist only

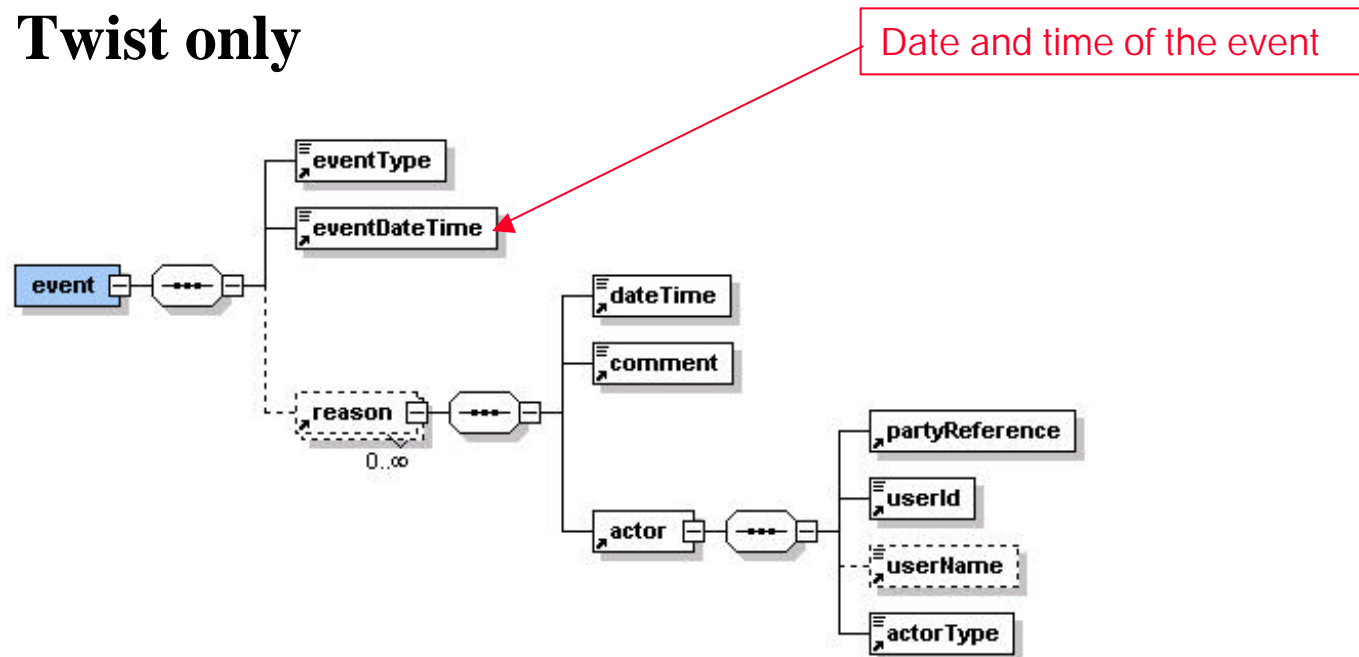

An event records the type of event and reasons given by the counterparties involved in agreeing to the details of the event.
One eventType is an AMND (amendment)

ProductList Element

Twist

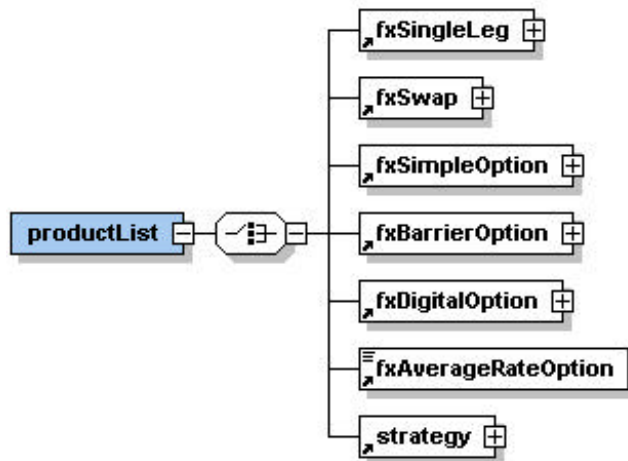

ProductList is implemented as an Entity only. It lists all of the products modeled. The list model is used by Twist but contains only the FX products. (NOTE: productList is an element in Twist for Display purposes only.)

FpML

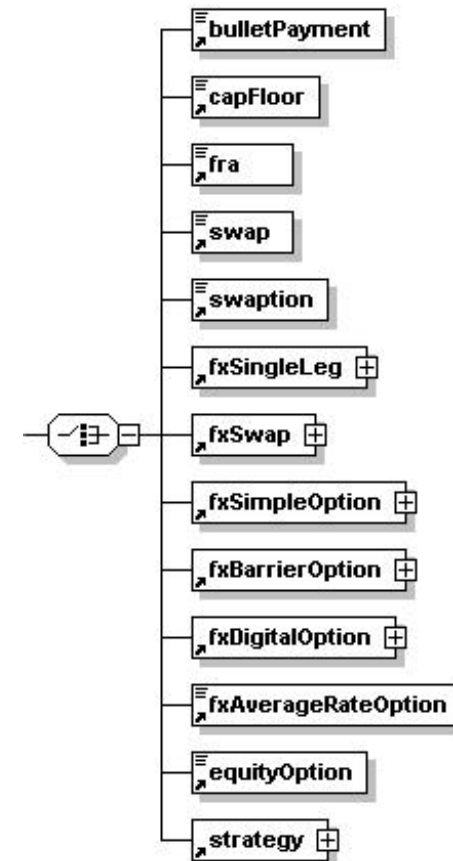

Strategy Element

Twist

FpML-fx

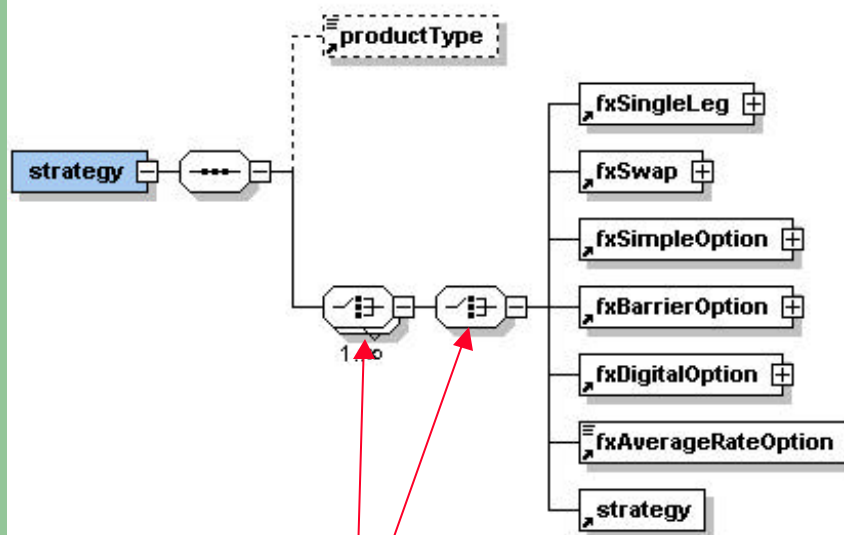

The combination of these two components indicates that a strategy is made of any number of products from the product list

Both Twist and FpML use the same model for strategy. Twist limits its view to the FX products.

FXSingleLeg Element

Twist

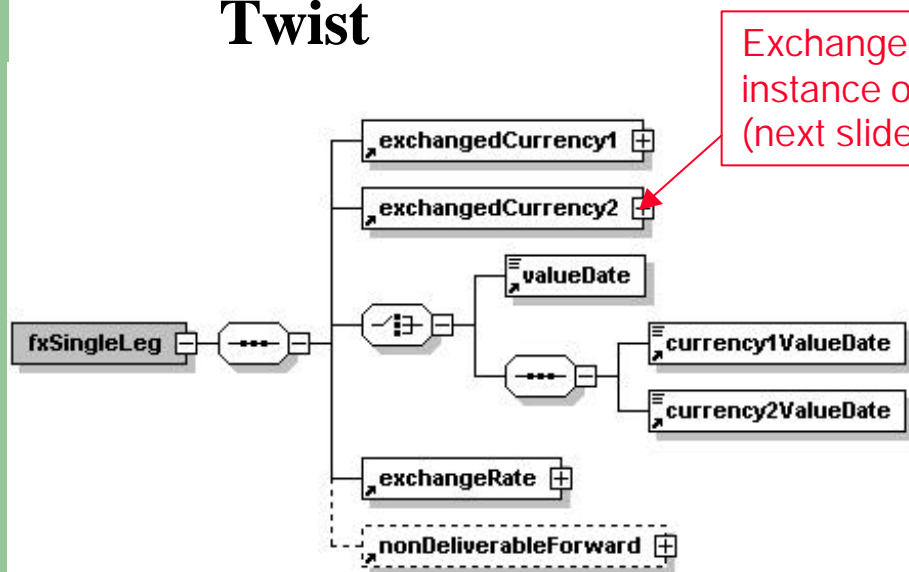

ExchangedCurrency is an instance of currencyFlow (next slide)

FpML-fx

Both models use a singleLeg to model both spots and forwards.

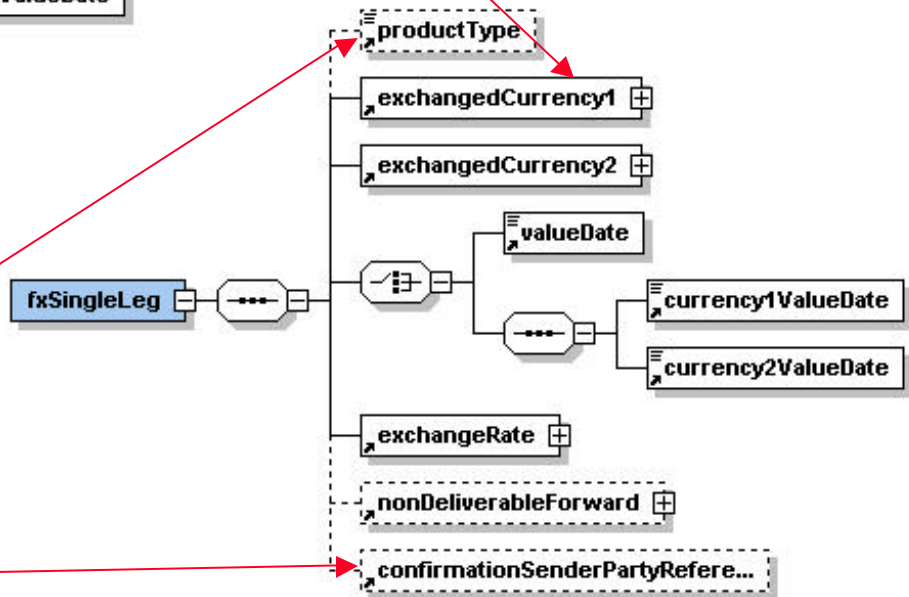

Placement and use of productType still under discussion

This element at trade level in Twist

CurrencyFlow Element

Twist and FpML

CurrencyFlow is the MoneyFlow element proposed by Twist and adopted by FpML. The basic Element represents the movement of an amount of currency from one party to another on a date. Settlement Information is included.

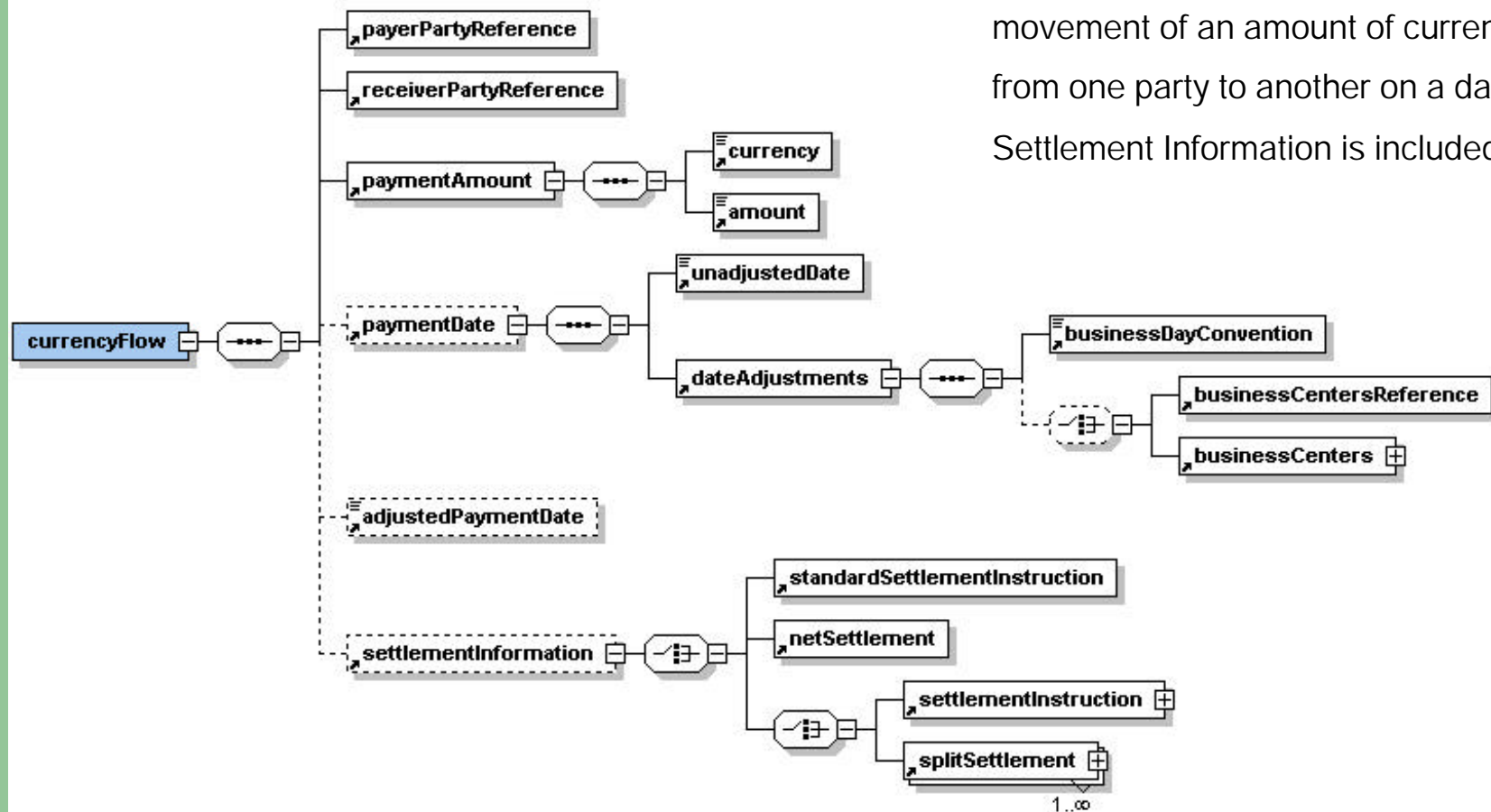

ExchangeRate Element

Twist and FpML-fx

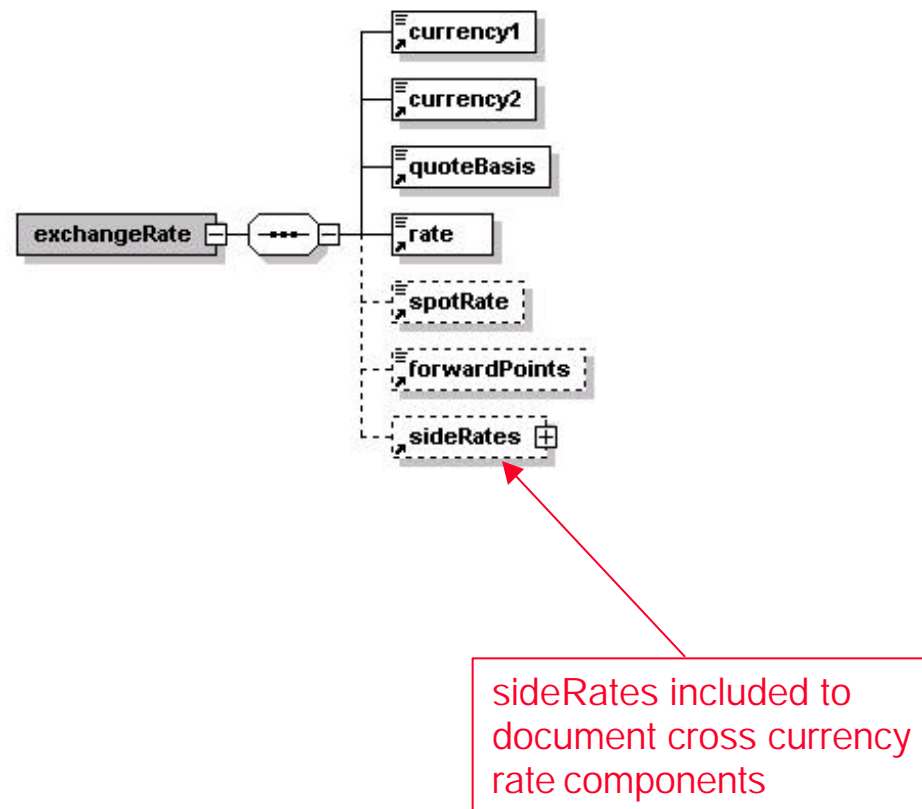

Twist and FpML-fx

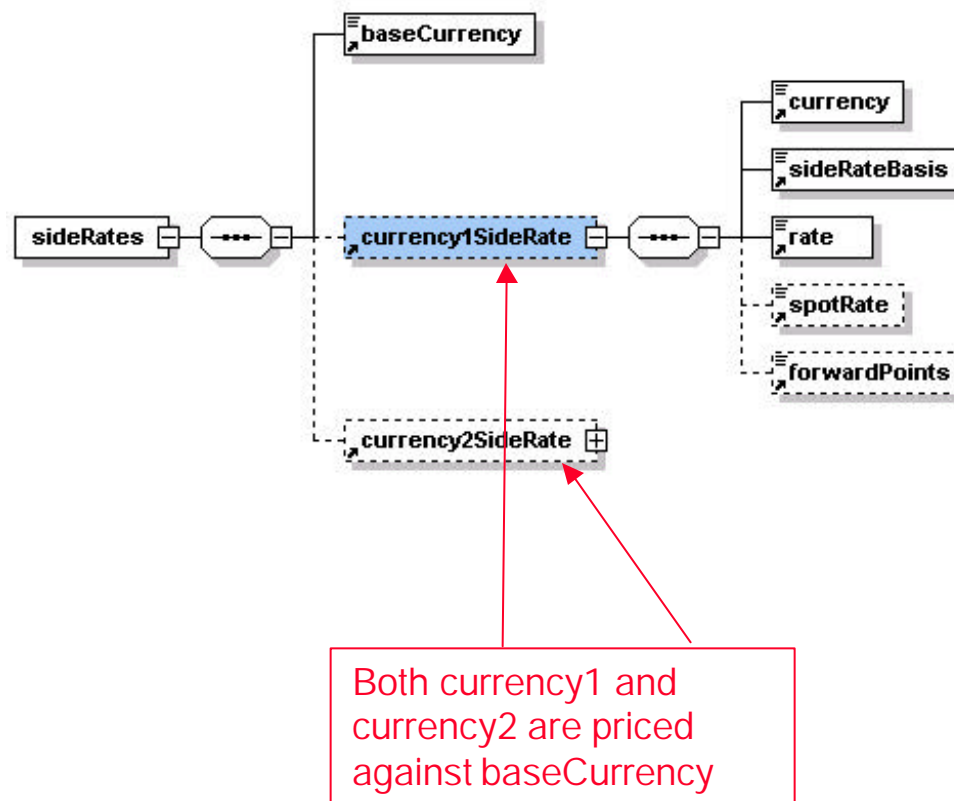

SettlementInstruction Element

Twist and Fpml

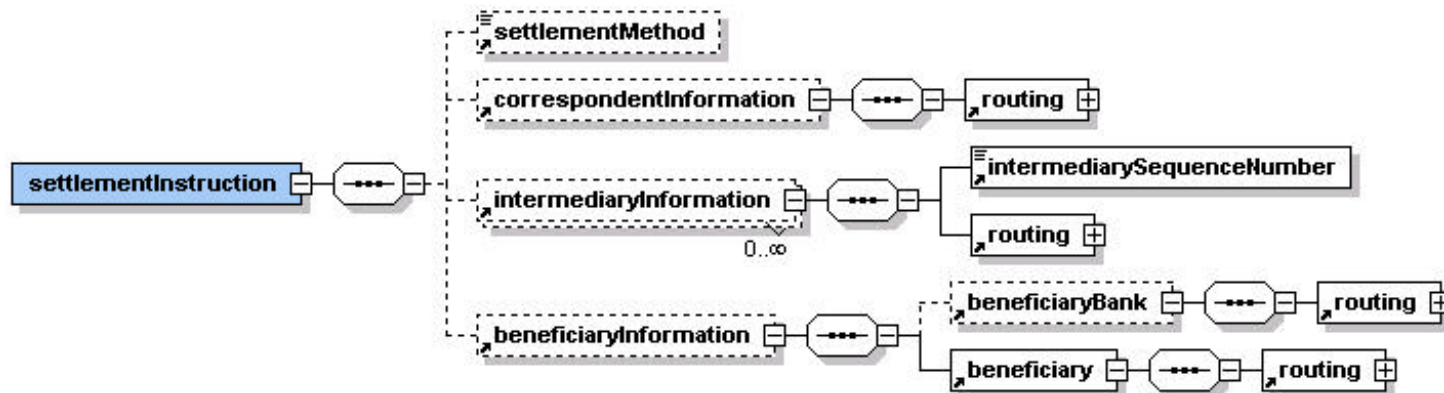

Routing Element

Twist and FpML

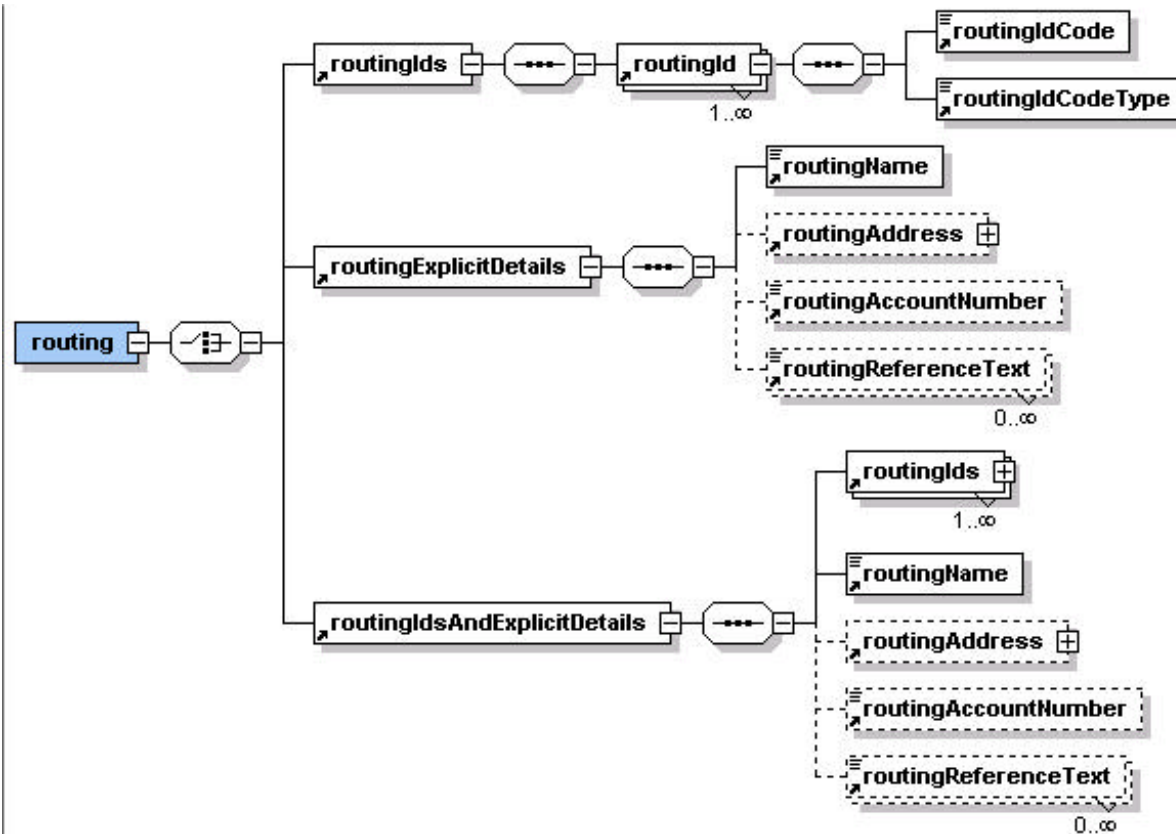

splitSettlement Element

Twist and FpML-fx

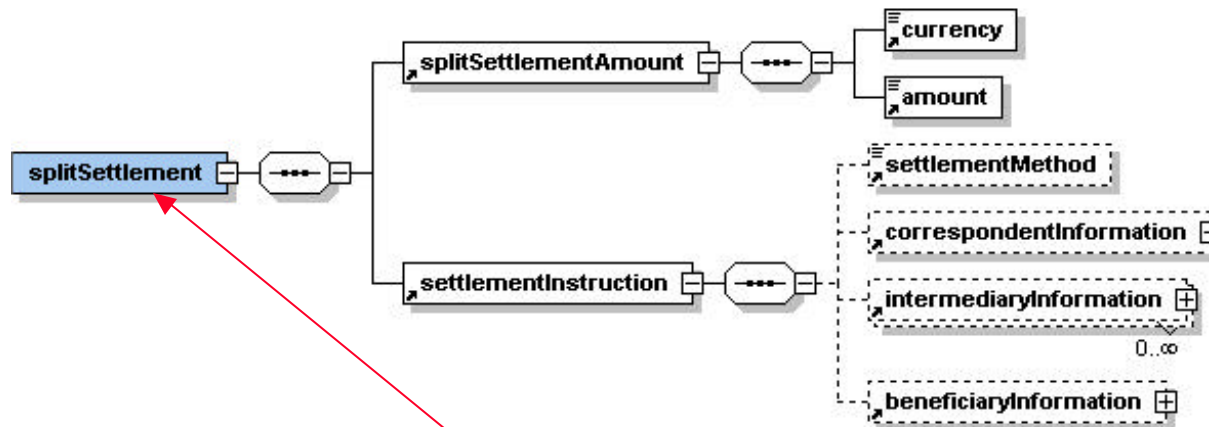

Two or more splitSettlements with amounts

nonDeliverable Forward Element

Twist and FpML-fx

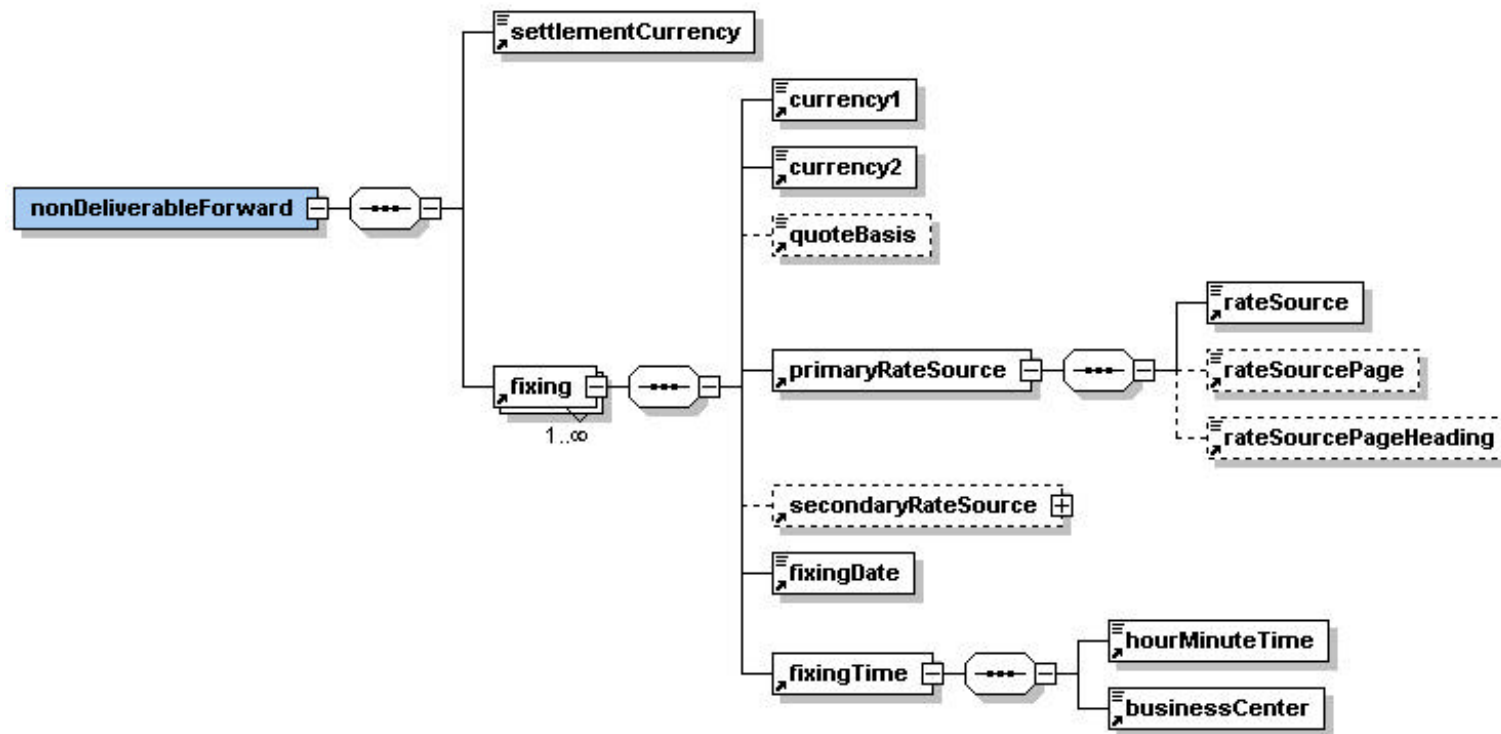

FXSwap Element

Twist

A swap is two single legs. The schema model in the future will set this cardinality. For now it's ≥ 1

FpML-fx

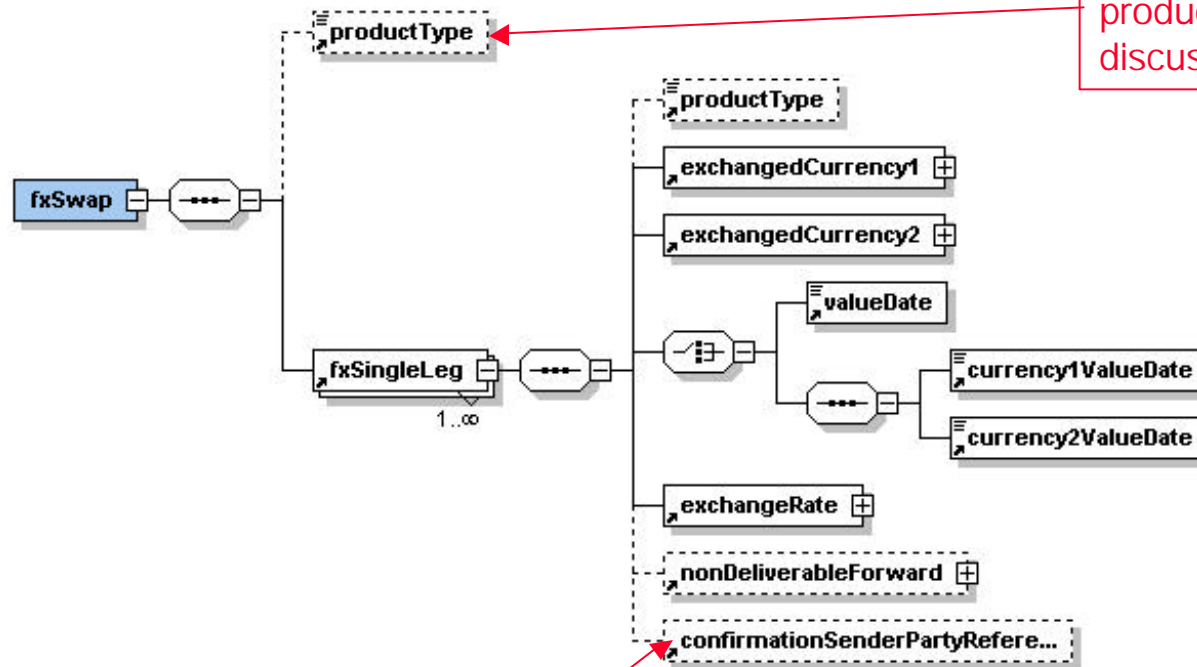

Placement and use of `productType` still under discussion

This element at trade level in Twist

FxSimpleOption Element

Twist and FpML-fx

Option work is being done by FpML-fx. Work is still in progress but current state reported here.

Twist will remain aligned with FpML for options.

NOTE: Exercise model is absent at present since it has not been integrated.

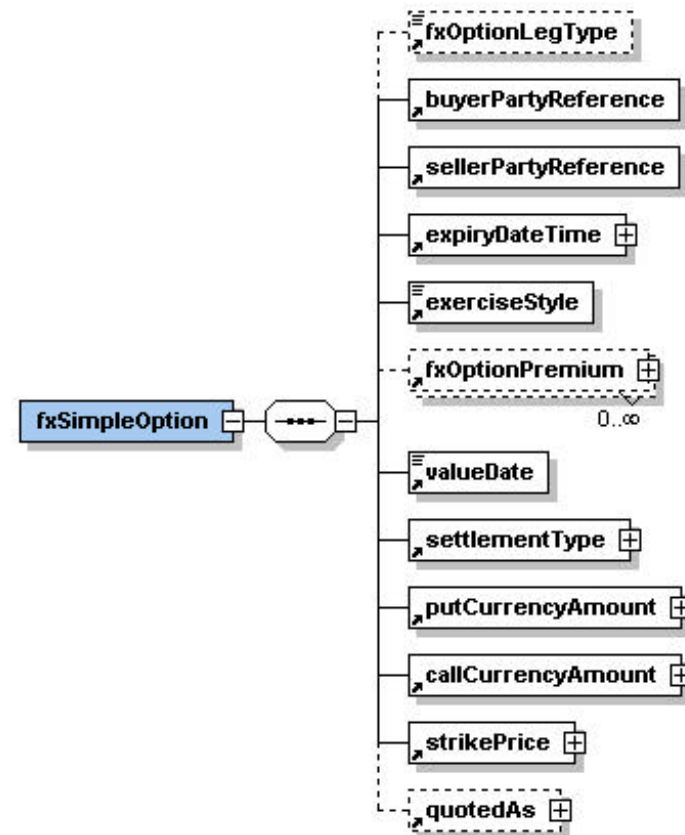

FxBarrierOption Element

Twist and FpML-fx

Option work is being done by FpML-fx. Work is still in progress but current state reported here.

NOTE: Exercise model is absent at present since it has not been integrated.

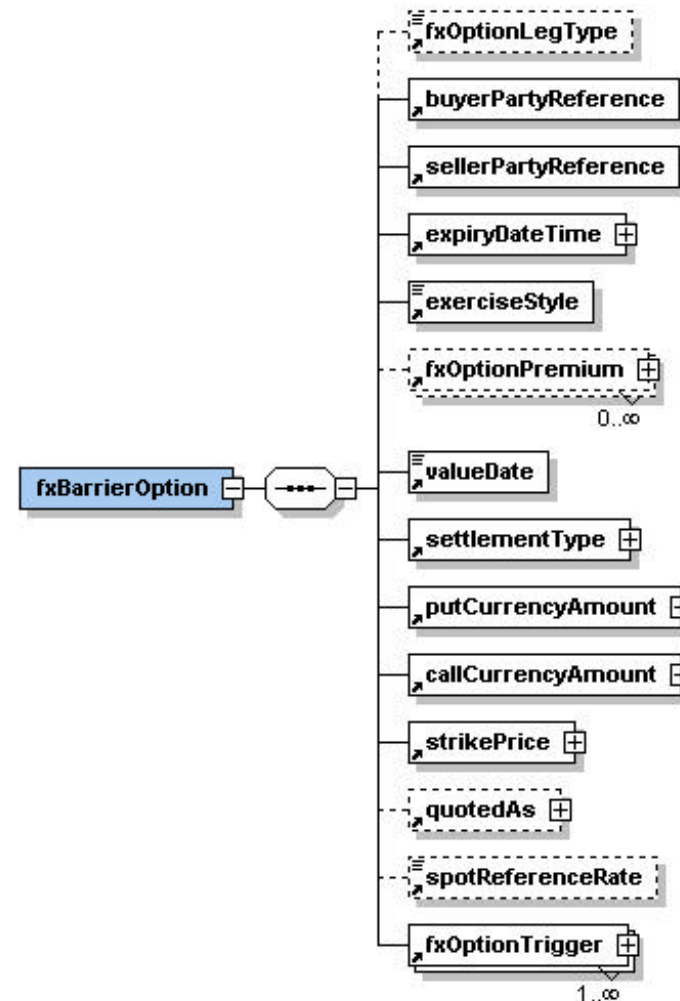

FxOptionTrigger Element

Twist and FpML-fx

Option work is being done by FpML-fx. Work is still in progress but current state reported here.

NOTE: Exercise model is absent at present since it has not been integrated.

